

OLISTEN 3

User Manual

English–Français–Italiano–Deutsch–Español

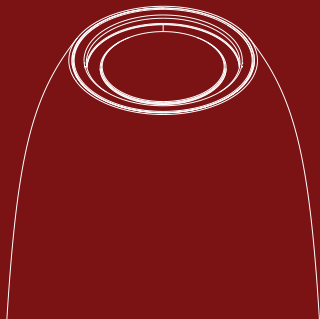

Thank you!

You made a great choice shopping with us. Thank you for your purchase. At TecTecTec! we truly care about our customers. If you have any issue at all with your device, we will work with you until you're happy! Please contact us at cs@tectectec.com.

! Warranty !

Subscribe online on [TecTecTec.com/register](https://tectectec.com/register) to register your product.

- 12-month warranty extension
- Priority Customer support
- 60 days of free return shipping
- Exclusive discounts

Please follow the instructions in this guide
to enjoy the greatest sound quality.

For more info and detailed tutorials please visit: [TecTecTec.com/olisten3](https://tectectec.com/olisten3)

English



Package Contents

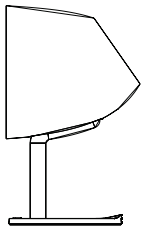

A

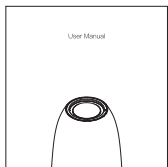

B



C



D



E



Remote Control

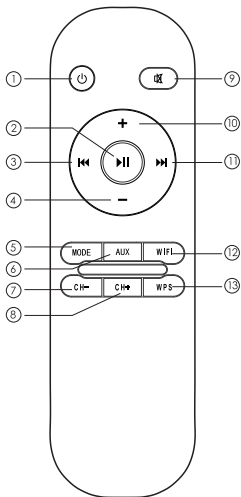

- ① Power ON/OFF
- ② Play/Pause
- ③ Previous Track
- ④ Volume Down
- ⑤ Mode
- ⑥ Aux Input
- ⑦ Previous Channel
- ⑧ Next Channel
- ⑨ Mute
- ⑩ Volume Up
- ⑪ Next Track
- ⑫ WiFi
- ⑬ WPS



Product Overview

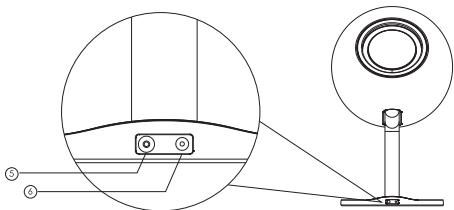
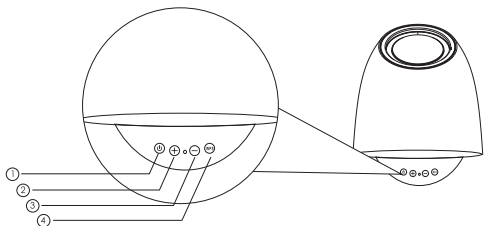

- ① Power ON/OFF, Mode Switch ② Volume Up
④ WPS/Channels Switch ⑤ AUX IN

- ③ Volume Down
⑥ DC



Speaker Operating Instructions

Power On:

- Briefly press power button "⏻" to turn ON the device.
- Press and hold the power button "⏻" to turn OFF the device.
- Briefly press the "⏮" / "⏭" buttons to increase/decrease VOLUME.
- Briefly press the "🎵" button twice to change PLAYLISTS.
- Press and hold the "🔄" button to RESET the device.

Switching Between Modes (WiFi Mode to AUX Input Mode):

Turn on the speaker. It will be in WiFi mode by default, and the LED indicator will be white.

Briefly press the button "⏻" to switch to AUX in mode. The LED will be green.

3 Methods of Connection

1. AUX Input Connection
2. Direct WiFi Connection
3. Network Connection (Connect through WiFi router)



1. AUX Input Connection

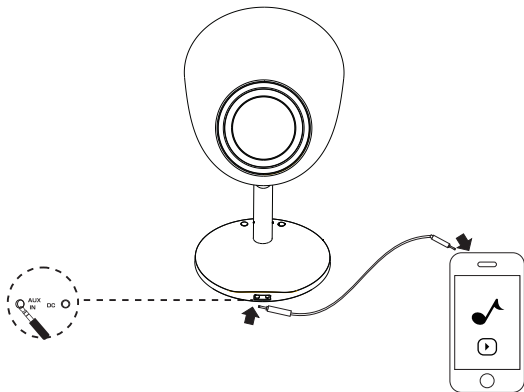

*Turn on the speaker. It is in WiFi mode by default.

Briefly press the power key "⏻" on the speaker or "AUX" button on the remote to change the mode to Aux In. You will see the LED light turn green. Connect an auxiliary device such as an MP3 player using an Aux cable connected to the speaker. You'll now be able to start playback from your device.



Installing the App

For iOS devices (iPhone,iPad, etc.):

Search for " MUZO " in Apple store and install the app.



For Android devices (Samsung, LG, etc.):

Search for " MUZO " in the Google play store and install the app.





2. Direct WiFi Connection

Turn on the speaker. It will be in WiFi mode by default. The Indicator LED will be white.

Direct Connect when there is no network.

- Turn on the speaker. It will be in WiFi mode by default.
- Enter the setting menu of your device and turn on WiFi.
- Search for the name of the speaker's WiFi network "OLISTEN 3-XXXX" and connect.
- Open the App to play music.

Note:

If the speaker has connected with network before, you may be required to input the password of the speaker during the connection. The password of the speaker is the password of the last router it connected with.

You can also play music using other Apps compatible with Airplay or DLNA.



3. Network Connection

Network Connection (Connect through WiFi router)

***Please make sure your phone is connected to 2.4GHz WiFi, and not 5GHz.**

For more info and detailed tutorials please visit: TecTecTec.com/olisten3

- Turn on the speaker. It is in WiFi mode by default.
- Enter the setting menu of your device and connect to your WiFi network
- Open the App "MUZO" and follow on the guide below to setup network connection.





3. Network Connection



1. Press "WiFi Setup Wizard" button and select Wireless_2.4G



2. Type the password of your WiFi network and press next.



3. You will see the interface shown above on your screen. Press the WPS button on the speaker. You will hear "searching for WiFi connection." press next when you see the following image on your screen.

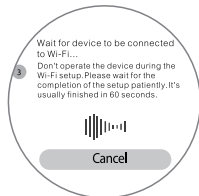

4. The App will search for the speaker and automatically add the speaker to your network.



3. Network Connection



5.Connection Succeed

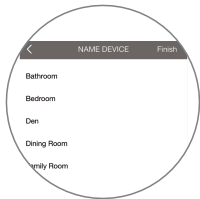

6.You can now select the speaker's name or rename it.

Note:

You can also play music using other Apps compatible with Airplay or DLNA.

Reasons for adding device failure:

1. The most likely reason is the WiFi router is 5G. This means that the device can't receive connection requests from the smart phone.
2. If you have a dual band router (5G+2.4G), please visit our website for detailed tutorials.
TecTecTec.com/olisten3
3. The router is hidden.
4. Some routers have a maximum number of connections. When this maximum is exceeded, it will fail to add more devices.
5. Network connectivity is poor. Connection might be successful after many tries.



Setting Playlist Presets

In WiFi mode, you can preset music playlists.

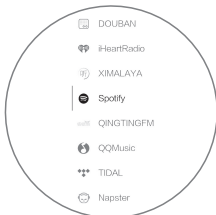

1. Choose Spotify or other music playing App.



2. Choose the playlist you'd like to hear.



3. You can preset no more than 6 playlists.



Safety and Maintenance

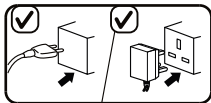
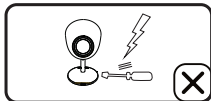
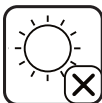
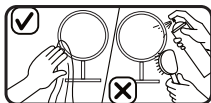



Specification



Model Name: OLISTEN 3



Product Size: 28.7*18.8*18.8cm



Power: DC 18V 2A



Frequency Response: 80Hz-18Hz



S/N: ≥ 75 db



WiFi



AUX IN 3.5MM



Material: Aluminum/ Plastic



2.1 Channel Speaker

More information



Please visit our website.

<http://TecTecTec.com/support>

You will find tutorials for OLISTEN 3.



Register warranty for your product.

<http://TecTecTec.com/register>

For one year warranty extension.



Follow "TecTecTec France" on Facebook

<https://www.facebook.com/tectectecfr/>

Free gift every month.



Any problem?

Contact us: cs@tectectec.com

Friendly customer service.

Thank you!

OLISTEN 3

Manuel d'utilisation



Français

Merci!

Merci et félicitations d'avoir choisi la OLISTEN 3. Bienvenue dans la famille TectecTec, nous sommes une jeune start-up française basée en Bretagne et à Bali. Nous sommes à votre disposition si vous avez des questions et ferons tout notre possible pour vous satisfaire. cs@tectectec.com

! Garantie !

Enregistrez dès maintenant la garantie de votre OLISTEN 3 sur : <http://TecTecTec.com/garantie>

- 12 mois d'extension de garantie gratuite
- Support client prioritaire
- Frais d'expédition de retour gratuits(30j)
- Réductions exclusives

Nous vous invitons à suivre les instructions de ce guide pour obtenir le meilleur des capacités de votre enceinte Olisten3.

**Nous vous invitons également à visiter la page suivante : TecTecTec.com/olisten3
Vous y trouverez de nombreuses informations et des tutoriels détaillés.**



Contenu du produit

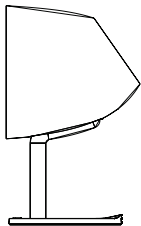

A

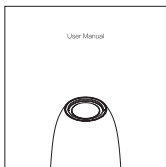

B



C



D



E



Télécommande

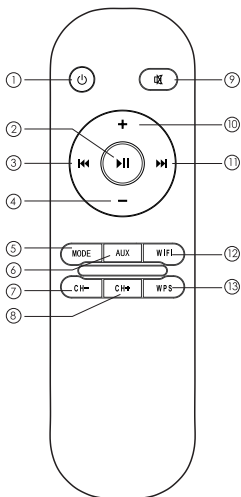

- ① Mise sous / hors tension
- ② Lecture / Pause
- ③ Piste précédente
- ④ Volume -
- ⑤ Mode
- ⑥ Entrée auxiliaire
- ⑦ Chaîne précédente
- ⑧ Chaîne suivant
- ⑨ Mode silencieux
- ⑩ Volume +
- ⑪ Piste suivant
- ⑫ WiFi
- ⑬ WPS



Présentation du produit

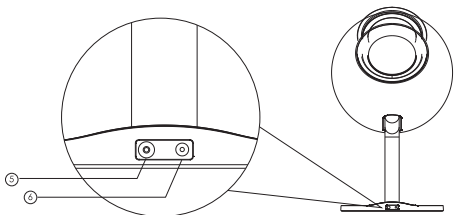
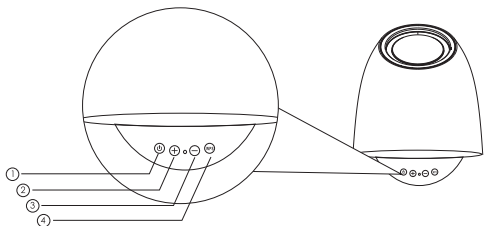

① Mise sous / hors tension

② Volume +

③ Volume -

④ WPS/Chaîne

⑤ AUX IN

⑥ Alimentation



Utilisation du haut-parleur

Allumer:

- Appuyez brièvement sur le bouton d'alimentation "⏻" pour allumer l'appareil.
- Appuyez sur le bouton d'alimentation "⏻" et maintenez-le enfoncé pour éteindre le périphérique.
- Appuyez brièvement sur les boutons "⏮" / "⏭" pour augmenter / diminuer le VOLUME.
- Appuyez deux fois brièvement sur le bouton "🎵" pour changer les PLAYLISTS.
- Appuyez sur le bouton "🔄" et maintenez-le enfoncé pour réinitialiser le périphérique.

Commutation entre les modes (mode Wi-Fi au mode d'entrée AUX):

Allumez le haut-parleur. Il sera en mode Wi-Fi par défaut, et l'indicateur LED sera blanc.

Appuyez brièvement sur le bouton "⏻" pour passer en AUX mode. La LED sera verte.

3 Méthodes de connexion

1. Connexion d'entrée AUX
2. Connexion WiFi directe
3. Connexion réseau (connexion via le routeur WiFi)



1. Connexion d'entrée AUX

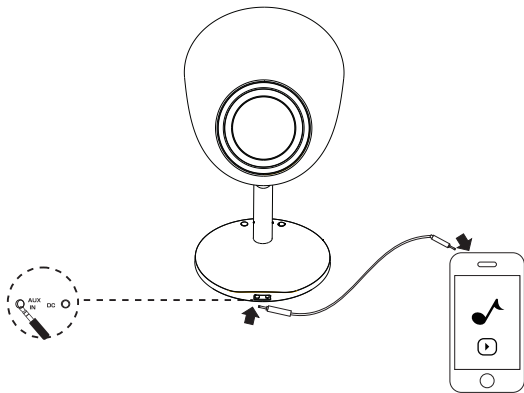

*Allumez le haut-parleur. Il sera en mode WiFi par défaut.

Appuyer brièvement sur la touche "Ⓜ" du haut-parleur ou sur le bouton "AUX" de la télécommande pour passer en mode Aux In. Vous verrez le voyant DEL s'allumer en vert. Connectez un périphérique auxiliaire tel qu'un lecteur MP3 à l'aide d'un câble Aux. Vous pouvez maintenant commencer la lecture à partir de votre appareil.



Installation de l'application

Pour les périphériques iOS (iPhone, iPad, etc.):

Recherchez "MUZO" dans l'Apple Store et installez l'application.





2. Connexion WiFi directe

Allumez le haut-parleur. Il sera en mode WiFi par défaut. La LED Indicatrice sera blanche.

Connexion directe lorsqu'il n'y a pas de réseau.

- Allumez le haut-parleur. Il sera en mode WiFi par défaut.
- Entrez dans le menu de configuration de votre appareil et activez WiFi.
- Recherchez le nom du réseau WiFi du haut-parleur "OLISTEN 3-XXXX" et connectez-vous.
- Ouvrez l'application et lancez la musique de votre choix.



Remarque:

Si le haut-parleur a été précédemment connecté à un réseau, vous devrez peut-être entrer le mot de passe du haut-parleur lors de la connexion. Le mot de passe du haut-parleur est le mot de passe du dernier routeur auquel il a été connecté.

Vous pouvez également jouer de la musique à l'aide d'autres applications compatibles avec Airplay ou DLNA.

3. Connexion réseau

Connexion réseau (connexion via le routeur WiFi)

***Assurez-vous que votre téléphone est connecté au Wi-Fi 2,4GHz, et non à 5 GHz. Pour plus d'informations et des tutoriels détaillés, nous vous invitons à visiter le lien: TecTecTec.com/olisten3**

- Allumez le haut-parleur. Il sera en mode WiFi par défaut.
- Entrez le menu de configuration de votre appareil et connectez-vous au réseau WiFi
- Ouvrez l'application "MUZO" et suivez le guide ci-dessous pour configurer une connexion réseau.





3. Connexion réseau



1. Appuyez sur le bouton "Assistant Configuration WiFi" et sélectionnez Wireless_2.4G



2. Entrez le mot de passe de votre réseau WiFi et appuyez sur Suivant.



3. L'interface ci-dessus apparaît sur votre écran. Appuyez sur le bouton WPS du haut-parleur. Vous entendrez "Searching for WiFi connection". Appuyez sur Suivant lorsque vous voyez apparaître l'image suivante sur votre écran.

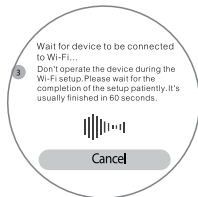

4. L'application recherchera le haut-parleur et ajoutera automatiquement le haut-parleur à votre réseau.



3. Connexion réseau



5. Connexion réussie.



6. Vous pouvez maintenant sélectionner le haut-parleur ou le renommer.

Remarque:

Vous pouvez également diffuser de la musique à l'aide d'autres applications compatibles avec Airplay ou DLNA.

Raisons d'échec de l'appareil:

1. La raison la plus probable est que le routeur WiFi soit en 5G. Cela signifie que l'appareil ne peut pas recevoir de requêtes de connexion du smartphone.
2. Si vous avez un routeur double bande (5G + 2.4G), visitez notre site Web sur lequel vous trouverez des tutoriels détaillés. TecTecTec.com/olisten3
3. Le routeur est caché.
4. Certains routeurs ont un nombre maximum de connexions. Lorsque ce maximum est dépassé, il ne sera plus possible d'ajouter d'autres périphériques.
5. La connectivité réseau est médiocre. La connexion peut être réussie après plusieurs essais.



Réglage des présélections de lecture

En mode WiFi, vous pouvez présélectionner les listes de lecture de musique.

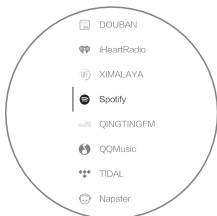

1. Sélectionnez Spotify ou une autre application de musique.



2. Choisissez la liste de lecture que vous souhaitez entendre.

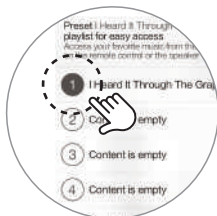

3. Vous ne pouvez pas ajouter plus de 6 listes de lecture.



Sécurité et entretien

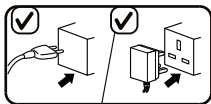
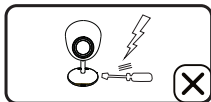
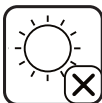
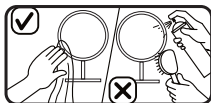



Caractéristiques



Nom du modèle: OLISTEN 3



Taille du produit: 28.7*18.8*18.8cm



Puissance: DC 18V 2A



Réponse en fréquence: 80Hz-18Hz



S/N: ≥ 75 db



WiFi



AUX IN 3.5MM



Matériaux: Aluminium, plastique



Haut-parleurs 2.1

Plus d'information



Visitez notre site :

<https://fr.TecTecTec.com/support>

Vous y trouverez des tutoriels pour OLISTEN 3.



Enregistrez votre garantie :

<https://TecTecTec.com/rgarantie>

1 an de garantie supplémentaire



Suivez nous sur Facebook "TecTecTec France"

<https://www.facebook.com/tectectecfr/>

Un cadeau à gagner tous les mois



Une question ?

Contactez-nous : cs@tectectec.com

TecTecTec Happy team

Merci!

OLISTEN 3

Manuale



Italiano

Grazie

Avete fatto un'ottima scelta ad acquistare presso di noi

Grazie per il vostro ordine

Noi di TecTecTec ci prendiamo davvero cura dei nostri clienti. Se riscontrate qualsiasi tipo di inconveniente con il vostro dispositivo noi faremo di tutto per aiutarvi fino a che sarete completamente soddisfatti!

! Garanzia !

Iscrivetevi online e ricevete, registrando il vostro articolo su:

[TecTecTec.com/register](https://www.tectectec.com/register)

- 12 mesi di estensione della garanzia
- Priorità servizio assistenza clienti
- 60 giorni di reso gratuito senza spese
- Sconti esclusivi

Ti preghiamo di seguire le seguenti istruzioni per
ottenere la migliore qualità del suono

Per maggiori dettagli e tutorials visita: [TecTecTec.com/olisten3](https://www.tectectec.com/olisten3)



Contenuto della Confezione

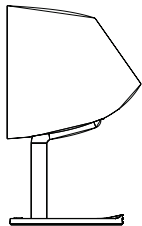

A

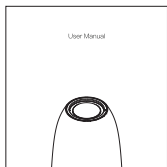

B



C



D



E



Telecomando

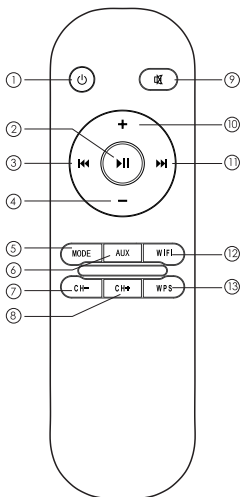

- ① Accensione On/OFF
- ② Play/ Pausa
- ③ Traccia Precedente
- ④ Volume Giu
- ⑤ Funzioni
- ⑥ Uscita AUX
- ⑦ Canale precedente
- ⑧ Canale successivo
- ⑨ Muto
- ⑩ Volume Su
- ⑪ Traccia successiva
- ⑫ WiFi
- ⑬ WPS



Caratteristiche Generali

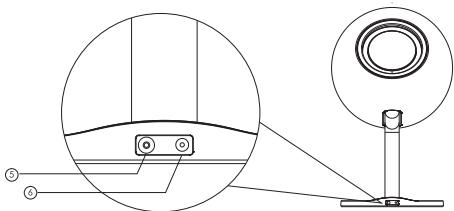
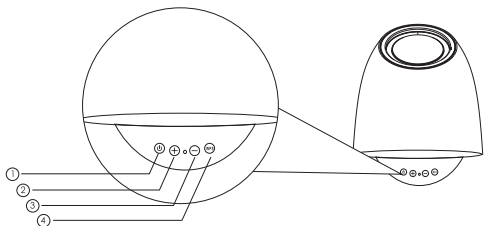

① Accensione On/OFF, Cambio Modalità

② Volume SU

③ Volume Giu

④ WPS/ Cambio Canale

⑤ Entrata Aux

⑥ DC



Istruzioni Funzioni dello Speaker

Accensione:

- Cliccare leggermente il pulsante di accensione "⏻" per accendere il dispositivo
- Tenere premuto il pulsante di accensione "⏻" per spegnere il dispositivo
- Cliccare leggermente i pulsanti "⏮" / "⏭" per aumentare o diminuire il VOLUME
- Cliccare leggermente e per due volte il pulsante "⏮" per cambiare PLAYLISTS
- Tenere premuto il pulsante "⏮" per resettare il dispositivo

Cambia tra le modalità (WiFi Mode ad Aux Input Mode)

Accendi lo speaker. Sarà impostato in modalità predefinita WiFi, l'indicatore LED apparirà di colore bianco. Premi leggermente il pulsante "⏻" Passa alla modalità AUX" Il LED diventerà di colore verde

3 Opzioni di Connessione

- 1 Connessione Aux Input
- 2 Connessione diretta WiFi
- 3 Connessione di rete (Collegamento attraverso il router WiFi)



1. Connessione Aux Input

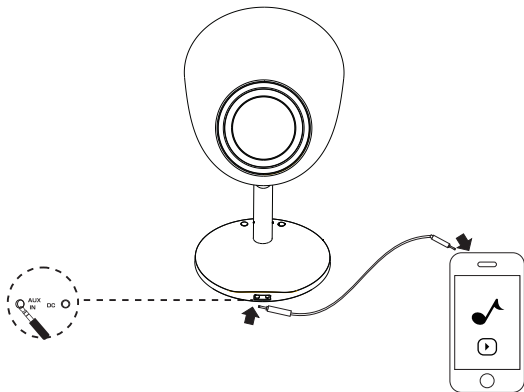

*Accendi lo speaker. Sarà automaticamente in modalità predefinita di WiFi. Premere leggermente il pulsante di accensione "Ⓢ" dello speaker oppure il pulsante AUX del telecomando per passare alla modalità Aux Input. Vedrai l'indicatore LED diventare verde. Collega un dispositivo ausiliare allo speaker. Potrai ora essere in grado di ascoltare le tracce audio dal tuo dispositivo



Installazione della APP

Per dispositivi iOS (iPhone,iPad, etc.):

Cerca per " MUZO " nell'Apple store ed installa la app





2. Connessione diretta WiFi

Accendi lo speaker. Sarà in modalità predefinita di WiFi. L'Indicatore LED sarà di colore bianco

Connessione diretta quando non c'è rete

- Accendi lo speaker sarà in modalità predefinita di WiFi
- Entra nel menù impostazioni del tuo dispositivo e accendi il WiFi
- Cerca il tuo speaker wifi network "OLISTEN 3-XXXX" e connetti.
- Apri la app per riprodurre la tua musica

Nota:

Se lo speaker era connesso precedentemente ad un'altra rete potrebbe chiederti di inserire la password dello speaker durante il collegamento

La password dello speaker è la password del tuo ultimo router a cui ti sei connesso.

Potrai anche riprodurre la musica usando altre applicazioni compatibili con Airplay o DLNA



3. Connessione di Rete

Connessione di rete (Collegamento attraverso il router WiFi)

*** Ti preghiamo di assicurarti che il tuo telefono sia connesso ad un WiFi 2,4 GHz e non ad una rete WiFi da 5 GHz. Per maggiori informazioni e dettagli visita il tutorials:[TecTecTec.com/olisten3](https://www.tectec.com/olisten3)**

- Accendi lo speaker. Sarà in modalità predefinita di WiFi
- Accedi al menu impostazioni del tuo dispositivo e connetti alla tua rete WiFi
- Apri la app MUZO e segui le istruzioni nella guida sotto alle impostazioni della connessione di rete





3. Connessione di Rete



1. Premi il pulsante "WiFi Setup Wizard" e seleziona Wireless_2.4GHz



2. Digita la password della tua rete WiFi e premi avanti



3. Vedrai mostrata l'interfaccia sopra il tuo schermo. Premi il pulsante WPS del tuo speaker. Sentirai "searching for WiFi connection". Premi Avanti quando vedrai la seguente immagine sul tuo schermo

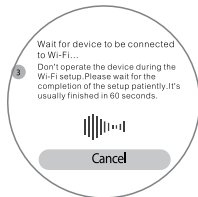

4. La applicazione ricercherà il collegamento con lo speaker ed automaticamente lo connetterà alla tua rete Wi-Fi



3. Connessione di Rete



5. Connessione avvenuta con successo



6. Potrai ora selezionare il tuo speaker e rinominare il dispositivo

Nota:

Potrai anche riprodurre la musica usando un'altra applicazione compatibile con Airplay oppure DLNA

Motivi per cui non puoi aggiungere dispositivi:

1. La causa più probabile è il tipo di router WiFi da 5GHz. questo significa che il dispositivo non potrà ricevere la connessione richiesta attraverso lo Smartphone
2. Se disponi di un router doppia banda (5GHz+2.4GHz), visita il nostro sito ufficiale per ulteriori dettagli e tutorials [TecTecTec.com/olisten3](https://www.tectec.com/olisten3)
3. Il router è nascosto
4. Alcuni Routers permettono un numero Massimo di connessioni. Quando questo limite è raggiunto o superato la connessione con altri dispositivi fallirà
5. La potenza di connessione è bassa; La connessione potrebbe avvenire con successo dopo diversi tentativi



Impostare playlists predefinite

In modalità WiFi puoi predefinire la tua lista di brani

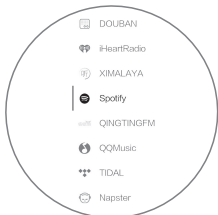

1. Scegli Spotify oppure altre applicazioni di riproduzione musica



2. Scegli la lista di brani che preferisci ascoltare

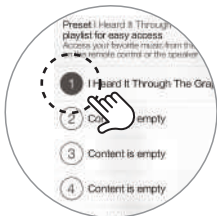

3. Potrai preselezionare un Massimo di 6 liste di brani



Sicurezza e manutenzione

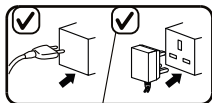
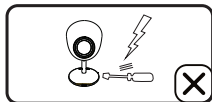
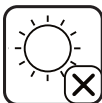
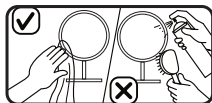



Specifiche tecniche



Nome modello: OLISTEN 3



Misure articolo: 28.7*18.8*18.8cm



Potenza: DC 18V 2A



Risposta di frequenza: 80Hz-18Hz



S/N: ≥ 75 db



WiFi



AUX IN 3.5MM



Materiale: Alluminio, Plastica



2.1 Canali Speaker

Maggiori informazioni



Visita il nostro sito ufficiale

<http://TecTecTec.com/support>

Troverai i tutorials per OLISTEN 3



Registra la garanzia del tuo articolo

<http://TecTecTec.com/register>

Otterai l'estensione di un anno di garanzia



Seguici sulla nostra pagina facebook "TecTecTec Italia"

<https://www.facebook.com/tectectecit/>



Riscontri dei problemi?

Contattaci a : it@tectectec.com

Amichevole e disponibile servizio clienti

Grazie!

OLISTEN 3

Gebrauchsanweisung



Deutsch

Vielen Dank!

Mit dem Kauf bei uns haben Sie eine großartige Wahl getroffen. Danke für Ihren Einkauf! Bei TecTecTec! Uns liegen unsere Kunden am Herzen. Wenn Sie Probleme gleich welcher Art mit Ihrem Gerät haben, dann werden wir mit Ihnen zusammenarbeiten, bis Sie zufrieden sind.! Bitte kontaktieren Sie uns unter de@tectectec.com.

! Garantie !

Registrieren Sie sich online unter [TecTecTec.com/register](https://www.tectectec.com/register), um Ihr Produkt zu registrieren.

- 12 Monate Garantieverlängerung
- Bevorzugter Kundensupport
- 60 Tage kostenloser Rückversand
- Exklusive Rabatte

Bitte folgen Sie den Anweisungen in diesem Leitfaden, um die bestmögliche Klangqualität zu genießen.

Für mehr Informationen und detaillierte Tutorien besuchen Sie bitte:
[TecTecTec.com/olisten3](https://www.tectectec.com/olisten3)



Packungsinhalt

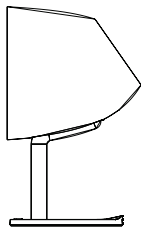

A

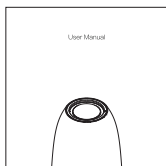

B



C



D



E



Fernbedienung

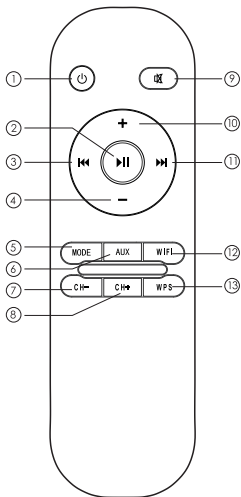

- ① Strom AN/AUS
- ② Abspielen/Pausieren
- ③ Vorheriger Titel
- ④ Lautstärke runter
- ⑤ Modus
- ⑥ Aux-Eingang
- ⑦ Vorheriger Kanal
- ⑧ Nächster Kanal
- ⑨ Stumm
- ⑩ Lautstärke rauf
- ⑪ Nächster Titel
- ⑫ Wi-Fi
- ⑬ WPS



Produktübersicht

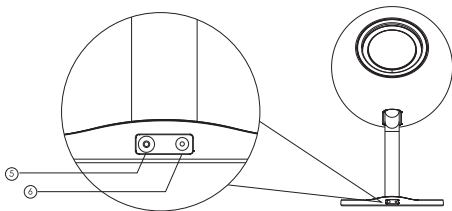
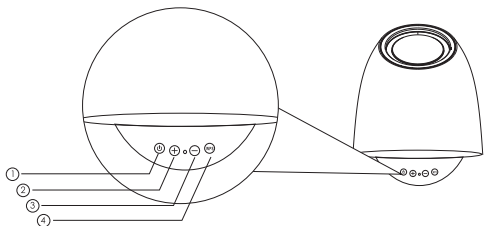







- ① Strom AN/AUS, Modus-Schalter ② Lautstärke rauf ③ Lautstärke runter
④ WPS/Kanal-Schalter ⑤ AUX IN ⑥ DC



Lautsprecher-Bedienungsanleitung

Einschalten:

- Drücken Sie kurz die An/Aus-Taste „“, um das Gerät einzuschalten.
- Drücken und halten Sie die An/Aus-Taste „“, um das Gerät auszuschalten.
- Drücken Sie kurz die „“ / „“-Tasten, um die LAUTSTÄRKE zu erhöhen/verringern.
- Drücken Sie kurz zweimal die „“-Taste, um die WIEDERGABELISTEN zu wechseln.
- Drücken und halten Sie die „“-Taste um das Gerät ZURÜCKZUSETZEN.

Umschalten zwischen (WiFi-Modus zu AUX-Eingang-Modus):

Schalten Sie den Lautsprecher ein. Er befindet sich standardmäßig im WiFi-Modus und die LED-Kontrollleuchte leuchtet weiß. Drücken Sie kurz den Knopf „“, um in den AUX-In-Modus umzuschalten. Die LED leuchtet grün.

3 Methoden der Verbindung

1. AUX-Eingang-Verbindung
2. Direkte WiFi-Verbindung
3. Netzwerkverbindung (verbinden über den WiFi-Router)



1. AUX-Eingang-Verbindung

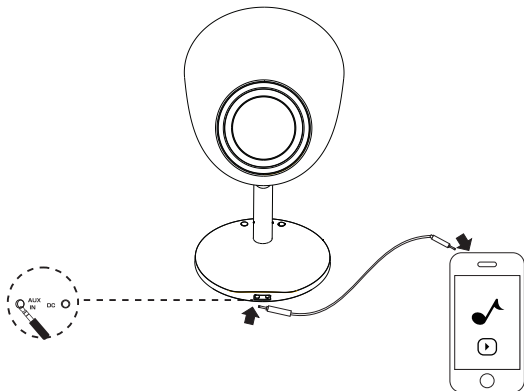

*Schalten Sie den Lautsprecher ein. Er befindet sich standardmäßig im WiFi-Modus.

Drücken Sie kurz auf die An/Aus-Taste „“ auf dem Lautsprecher oder die „AUX“-Taste auf der Fernbedienung, um den Modus auf Aux-In zu ändern. Die LED-Lampe leuchtet grün. Verbinden Sie ein Zusatzgerät wie einen MP3-Spieler über ein Aux-Kabel, das mit dem Lautsprecher verbunden ist. Sie sind nun in der Lage, die Wiedergabe von Ihrem Gerät zu starten.



Installation der App

Für iOS-Geräte (iPhone, iPad usw.):

Suchen Sie im Apple Store nach „MUZO“ und installieren Sie die App.



Für Android-Geräte (Samsung, LG usw.):

Suchen Sie im Google Play Store nach „MUZO“ und installieren Sie die App.





2. Direkte WiFi-Verbindung

Schalten Sie den Lautsprecher ein. Er befindet sich standardmäßig im WiFi-Modus. Die Kontroll-LED leuchtet weiß.

Direkte Verbindung bei fehlendem Netzwerk

- Schalten Sie den Lautsprecher ein. Er befindet sich standardmäßig im WiFi-Modus.
- Gehen Sie das Einstellungsmenü Ihres Gerätes und schalten Sie das Wi-Fi an.
- Suchen Sie nach dem Namen des Lautsprecher-WiFi-Netzwerks, „OLISTEN 3-XXXX“ und verbinden Sie es.
- Öffnen Sie die App, um Musik abzuspielen.



Anmerkung:

Wenn sich der Lautsprecher bereits mit dem Netzwerk verbunden hat, kann es sein, dass Sie dazu aufgefordert werden, das Passwort des Lautspeakers während des Verbindungsvorgangs einzugeben. Das Passwort des Lautspeakers ist das Passwort des letzten Routers, mit dem er verbunden war.

Sie können Musik auch mit anderen Apps abspielen, die mit AirPlay oder DLNA kompatibel sind.

3. Netzwerkverbindung

Netzwerkverbindung (verbinden über den WiFi-Router)

***Bitte stellen Sie sicher, dass Ihr Handy mit 2,4 GHz mit dem WiFi verbunden ist und nicht mit 5 GHz. Für mehr Informationen und detaillierte Tutorien besuchen Sie bitte: TecTecTec.com/olisten3**

- Schalten Sie den Lautsprecher ein. Er befindet sich standardmäßig im WiFi-Modus.
- Gehen Sie in das Einstellungsmenü Ihres Gerätes und verbinden Sie Ihr WiFi-Netzwerk.
- Öffnen Sie die App „MUZO“ und folgen Sie dem untenstehenden Leitfaden, um die Netzwerkverbindung einzurichten.





3. Netzwerkverbindung



1. Drücken Sie den „WiFi Setup Wizard“-Knopf und wählen Sie 2Wireless_2.4G“.



2. Geben Sie das Passwort Ihres WiFi-Netzwerks ein und klicken Sie „Weiter“.



3. Sie werden die obengezeigte Maske auf Ihrem Bildschirm sehen. Drücken Sie die die WPS-Taste auf dem Lautsprecher. Sie werden „searching for WiFi connection“ hören. Drücken Sie „Next“, wenn Sie das folgende Bild auf Ihrem Bildschirm sehen.

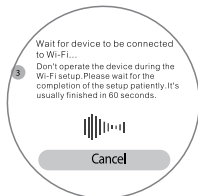

4. Die App wird nach dem Lautsprecher suchen und diesen automatisch zu Ihrem Netzwerk hinzufügen.



3. Netzwerkverbindung



5. Verbindung erfolgreich



6. Sie können jetzt den Lautsprechernamen auswählen oder ihn umbenennen.

Anmerkung:

Sie können Musik auch mit anderen Apps abspielen, die mit Airplay oder DLNA kompatibel sind.

Ursache für einen Gerätefehler:

1. Der wahrscheinlichste Grund ist, dass der WiFi-Router auf 5G steht. Das bedeutet, dass das Gerät keine Verbindungsanfragen vom Smartphone erhalten kann.
2. Wenn Sie über einen Dualband-Router (5G + 2,4G) verfügen, dann besuchen Sie für detaillierte Tutorien bitte unsere Webseite. [TecTecTec.com/olisten3](https://www.tectec.com/olisten3)
1. Der Router ist versteckt.
2. Einige Router haben eine maximale Anzahl an Verbindungen. Wenn dieses Maximum überschritten ist, wird es nicht gelingen, weitere Geräte hinzuzufügen.
3. Netzwerkverbindung ist schwach. Die Verbindung kann nach vielen Versuchen erfolgreich sein.



Voreinstellungen der Wiedergabeliste

Im WiFi-Modus können Sie die Musik-Wiedergabeliste voreinstellen.

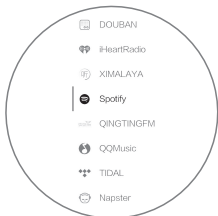

1. Wählen Sie Spotify oder eine andere App zur Musikwiedergabe.



2. Wählen Sie die Wiedergabeliste aus, die Sie sich gerne anhören möchten.

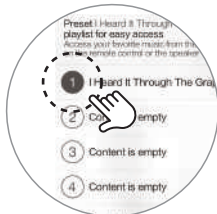

3. Sie können vorab nicht mehr als 6 Wiedergabelisten einstellen.



Sicherheit und Wartung

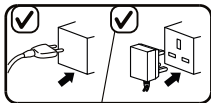
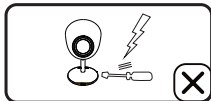
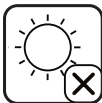
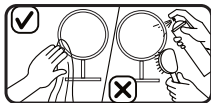



Spezifikationen



Modellname: OLISTEN 3



Produktgröße: 28.7*18.8*18.8cm



Leistung: DC 18V 2A



Frequenzantwort: 80Hz-18Hz



S/N: ≥ 75 db



Wi-Fi



AUX IN 3.5MM



Material: Aluminium/Plastik



2.1 Kanallautsprecher

Mehr Informationen



Bitte besuchen Sie unsere Webseite:

<http://TecTecTec.com/support>

Sie werden dort Tutorien für den OLISTEN 3 finden. Für eine einjährige Garantieverlängerung.



Registrieren Sie die Garantie für Ihr Produkt.

<http://TecTecTec.com/register>



Folgen sie „TecTecTec France“ auf Facebook:

<https://www.facebook.com/tectectecfr/>

Jeden Monat ein kostenloses Geschenk.



Haben Sie irgendwelche Probleme?

Kontaktieren Sie uns: de@tectectec.com

Freundlicher Kundendienst

Vielen Dank!

OLISTEN 3

Manuel d'utilisation



Español

Gracias !

¡Gracias y felicitaciones por elegir la cámara deportiva TecTecTec!

! Garantía !

Registre su OListen 3 para gozar de la garantía : [TecTecTec.com/register](https://www.tectec.com/register)

- Estensione garantía per 12 mesi gratuita
- Atención al cliente 5 estrellas
- Garantía de 60 días de devolución de dinero
- Descuento exclusivo

Siga las instrucciones de esta guía para disfrutar de la mejor calidad de sonido.

Para obtener más información y tutoriales detallados, visite: [TecTecTec.com/olisten3](https://www.tectec.com/olisten3)

Español



Contenidos del paquete

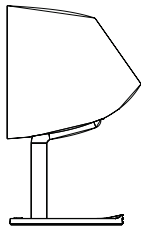

A

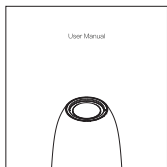

B

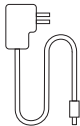

C



D



E



Mando a distancia

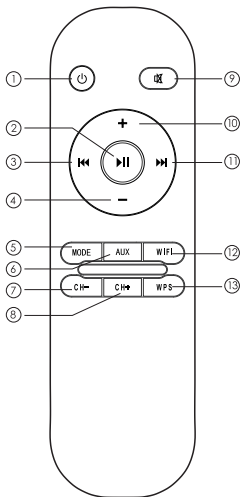

- ① ON/OFF
- ② Play/Pause
- ③ Canción anterior
- ④ Bajar volumen
- ⑤ Modo
- ⑥ Aux Input
- ⑦ Cadena anterior
- ⑧ Cadena siguiente
- ⑨ Mute
- ⑩ Subir volumen
- ⑪ Canción siguiente
- ⑫ WiFi
- ⑬ WPS



Descripción del producto

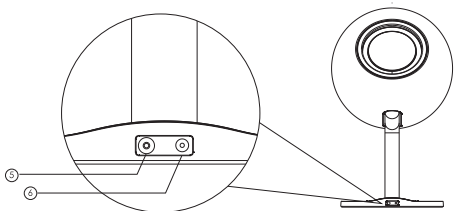
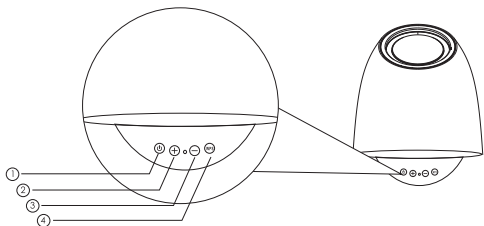

① ON/OFF, Cambio de modo

② Subir volumen

③ Bajar volumen

④ WPS/ Cambio cadena

⑤ AUX IN

⑥ DC



Instrucciones de uso

ON:

- Pulse brevemente el botón "⏻" para encender el dispositivo.
- Mantenga presionado el botón "⏻" para apagar el dispositivo.
- Pulse brevemente los botones "⏩" / "⏪" para aumentar / disminuir VOLUMEN.
- Pulse brevemente el botón "⏮" dos veces para cambiar PLAYLISTS.
- Pulse y mantenga presionado el botón "⏻" para hacer un reset del dispositivo.

Cambio entre modos (modo WiFi a modo AUX):

Enciende el altavoz. Estará en modo WiFi con los parámetros iniciales, y el indicador LED será blanco. Pulse brevemente el botón "⏻" para cambiar al modo AUX. El LED estará verde.

3 métodos de conexión

1. AUX Input conexión
2. WiFi conexión
3. Conexión con WiFi dispositivo (red)



1. AUX Input conexión

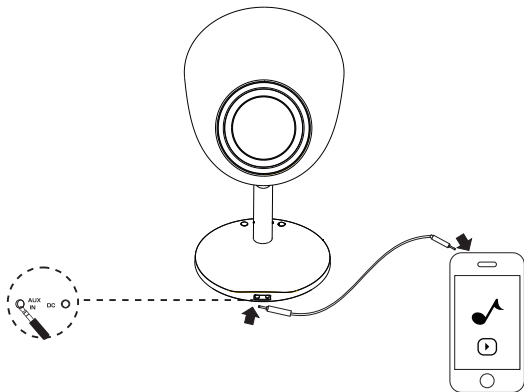

* Encienda el altavoz. Está en modo WiFi de forma predeterminada. Presione brevemente el botón "Ⓜ" en el altavoz o el botón "AUX" en el mando a distancia para cambiar el modo a Aux In. Verá que la luz LED se vuelve verde. Conecte un dispositivo auxiliar como un reproductor de MP3 utilizando un cable auxiliar conectado al altavoz. Ahora podrá iniciar la reproducción desde su dispositivo.



Instalar la aplicación

Con dispositivos iOS (iPhone, iPad, etc..)

Hay que buscar "Muzo" en el Apple Store y instalar la aplicación.



Con dispositivos Android (Samsung, LG, etc.):

Hay que buscar "Muzo" en el Google Play y instalar la aplicación.





2. Conexión al WiFi

Enciende el altavoz. Está en modo WiFi de forma predeterminada. El Indicador LED será blanco

- Enciende el altavoz. Está en modo WiFi de forma predeterminada.
- Enciende el WiFi de su dispositivo.
- Busca la red WiFi del altavoz "Olisten 3-XXXX" y conéctese.
- En la aplicación, ponga música



Nota:

Si el altavoz se ha conectado anteriormente a una red, es posible que deba ingresar la contraseña del altavoz durante la conexión. La contraseña del altavoz es la contraseña del último enrutador con el que se conectó. También puede reproducir música con otras aplicaciones compatibles con AirPlay o DLNA.



3. Conexión con WiFi dispositivo

***Asegúrese de que su teléfono está conectado a 2.4GHz WiFi, y no 5GHz.**

Para obtener más información y tutoriales detallados, visite:

TecTecTec.com/olisten3

- Enciende el altavoz. Está en modo WiFi de forma predeterminada.
- Enciende el WiFi de su dispositivo
- En la ap "Muzo" siga las instrucciones siguientes:





3. Conexión con WiFi dispositivo



1. Pulsa el botón "Wifi Setup Wizard" y elige Wireless_2.4G



2. Indicar la contraseña de su Wifi y pulsar next.



3. Podrá ver la imagen siguiente en la pantalla de su teléfono. Pulsa el botón WPS en el altavoz. Se escucha "Searching for Wifi connection". Pulsa "next" cuando se ve la imagen siguiente en la pantalla de su teléfono.

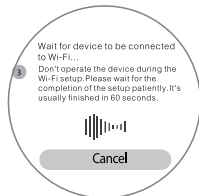

4. La ap buscara el altavoz y le añadirá a sus dispositivos.



3. Conexión con WiFi dispositivo



5. Conexión ok



6. Puede elegir el altavoz y cambiar el nombre

Nota:

También puede reproducir música con otras aplicaciones compatibles con Airplay o DLNA.

Razones para añadir fallos al dispositivo:

1. La razón más probable es que el enrutador WiFi es 5G. Esto significa que el dispositivo no puede recibir solicitudes de conexión desde el teléfono.
2. Si usted tiene un enrutador dual de la venda (5G + 2.4G), visite por favor nuestro Website para tutoriales detallados. TecTecTec.com/olisten3
3. El enrutador está oculto.
4. Algunos enrutadores tienen un número máximo de conexiones. Cuando se exceda este máximo, no podrá agregar más dispositivos.
5. La conectividad de la red es pobre. La conexión podría tener éxito después de muchos intentos.



Playlist menu

En el modo WiFi, puede preestablecer listas de música.

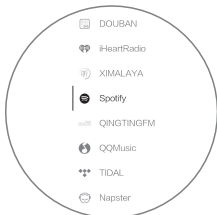

1. Elija Spotify u otra aplicación que reproduzca música.



2. Elija la lista de música que desea escuchar.



3. Puede predefinir no más de 6 listas de música.



Seguridad y mantenimiento

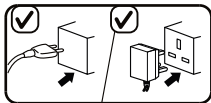
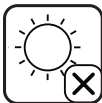
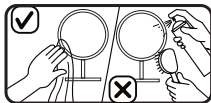



Especificaciones



Nombre: OLISTEN 3



Tamaño del producto: 28.7*18.8*18.8cm



Power: DC 18V 2A



Frecuencia: 80Hz-18Hz



S/N: ≥ 75 db



WiFi



AUX IN 3.5MM



Material: Aluminio, Plastico



2.1 Channel Speaker

Más información



Por favor visite nuestro sitio web

<http://TecTecTec.com/support>

usted encontrará clases tutoriales para Olisten 3.



Suscríbase a nuestra Garantía

<http://TecTecTec.com/register>

consiga descuentos exclusivos



Síguenos sobre Facebook

<https://www.facebook.com/tectectecfr/>

Free gift every month.



¿ Un problema?

Contact us: es@tectectec.com

Póngase en contacto con nosotros

Gracias!



TecTecTec!